

STOCK FINISHES

Body - Powder Coat - Satin Black, Gloss White

Moldings / Drawer Handles / Clip-on Bar

Powder Coat - Satin Black, Polished Aluminum, Polished Brass

Wheel Shrouds: Satin Black, Metallic Silver, Gloss White

AS SHOWN:

Body: Satin Black Powder Coat

Moldings: Polished Aluminum Powder Coat

Drawer Handles: Polished Aluminum Powder Coat

Wheel Shrouds: Satin Black

OPTIONS AVAILABLE:

Stationary Serving Package (Removable Bar Surface, Speed-rail)

Custom Logos (dual sides)

Custom Body Color (other than black or white)

Custom Trim Color (other than gold, silver, or black)

Custom Color Wheel Covers (other than silver or black)

Custom Graphic Vinyl Wrap (such as woodgrain or graphics)

Umbrella Bracket

3XS

BARMOBILE®

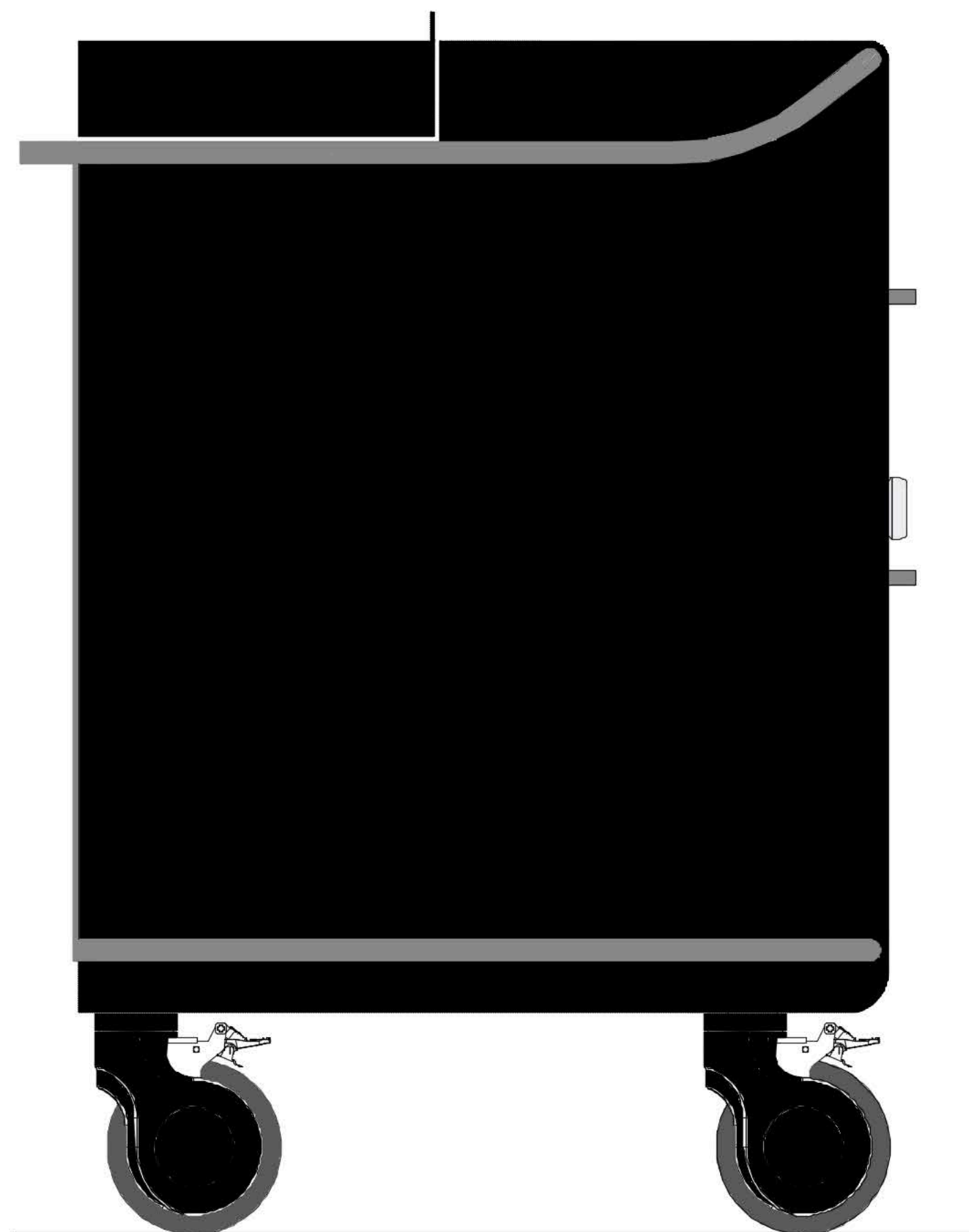
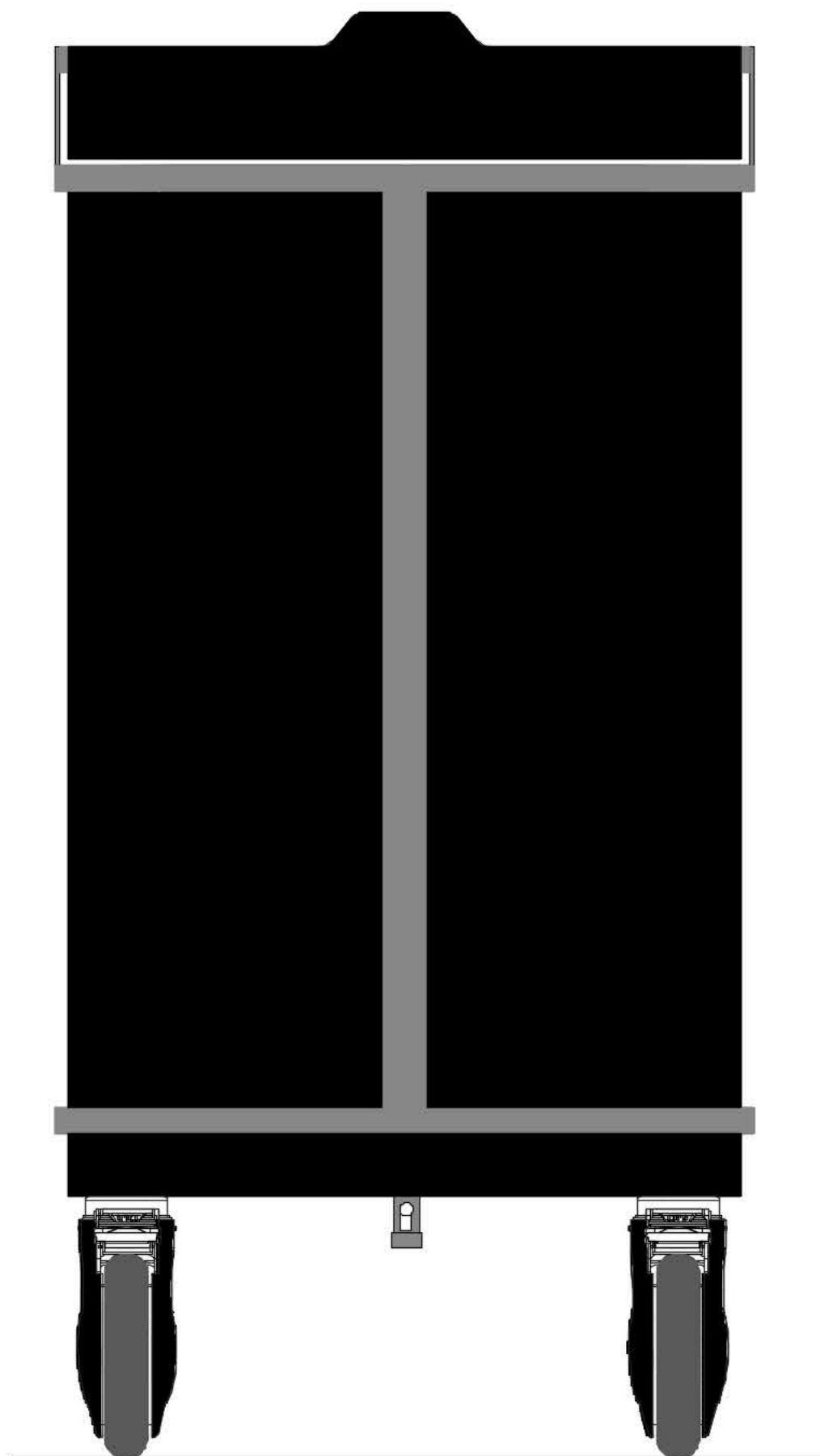
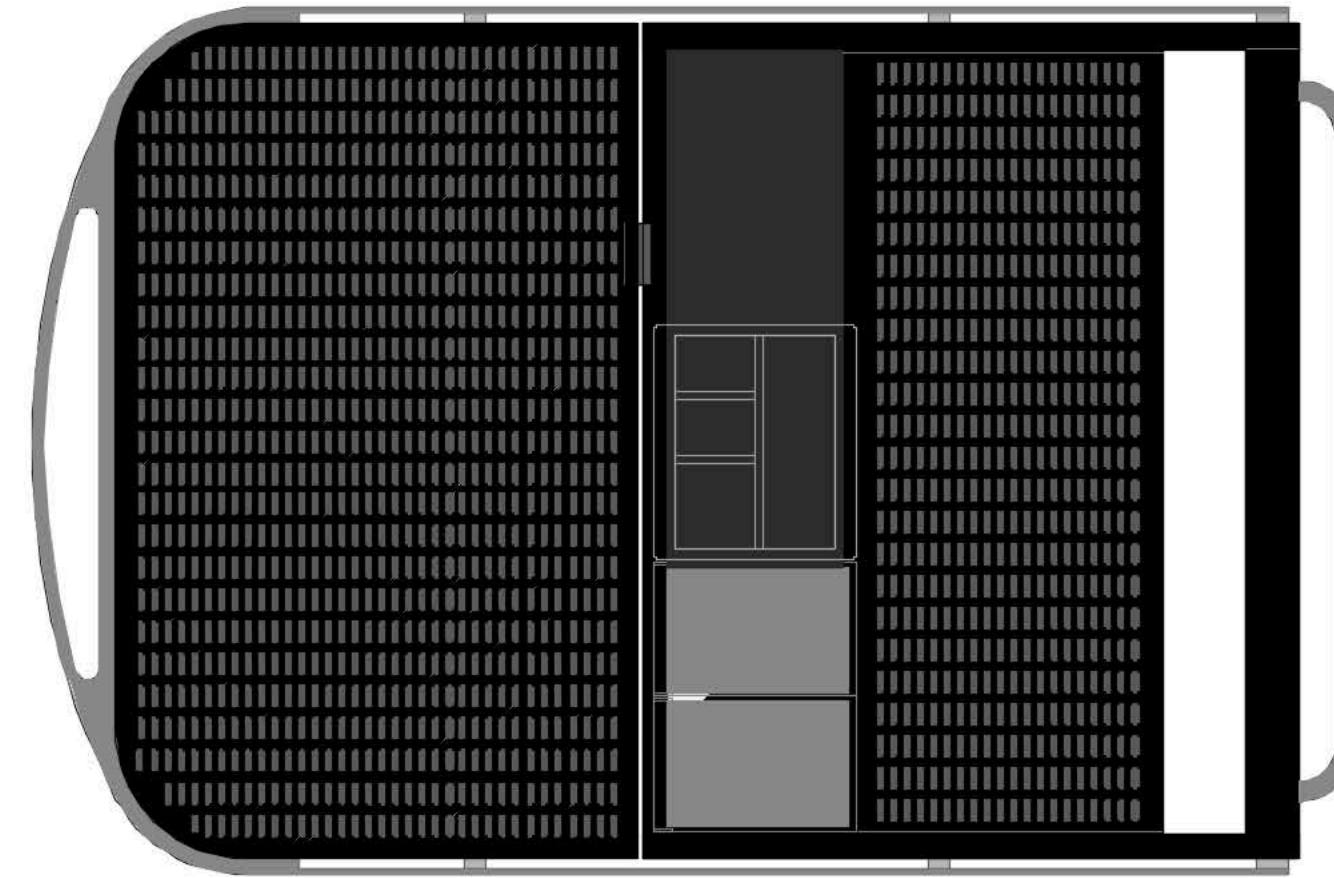

3XR | BARMOBILE®

Primary Operation Features

PATENT PENDING

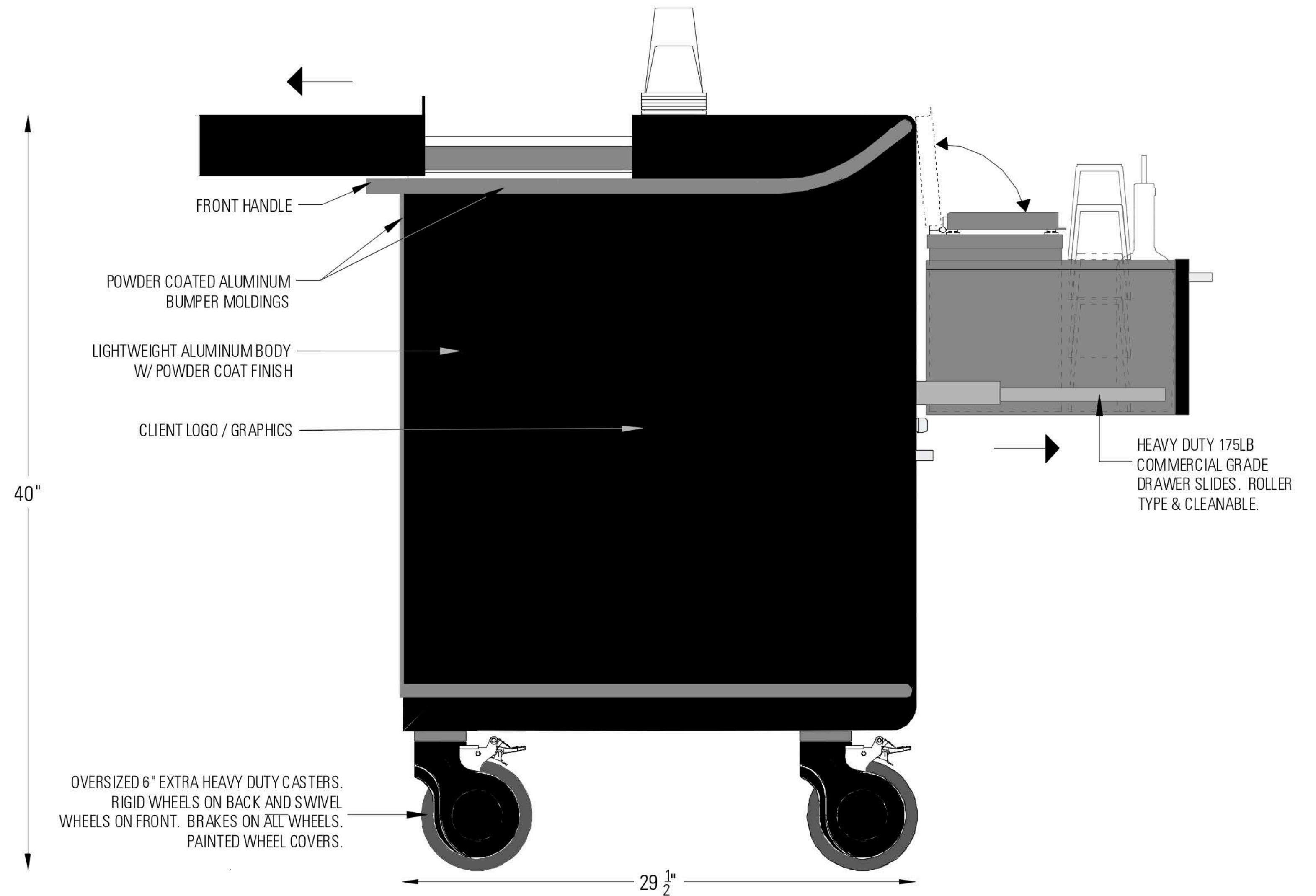
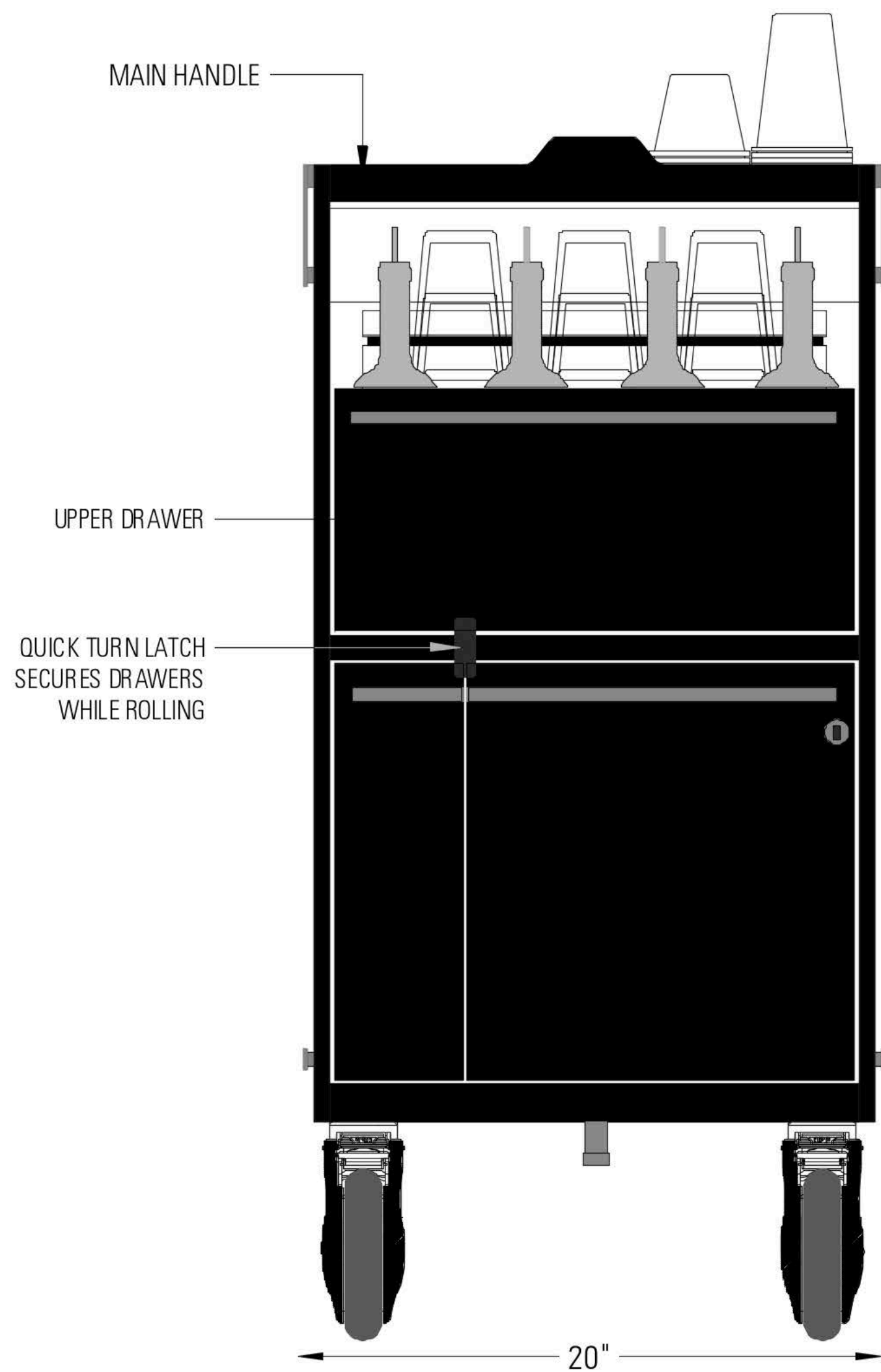
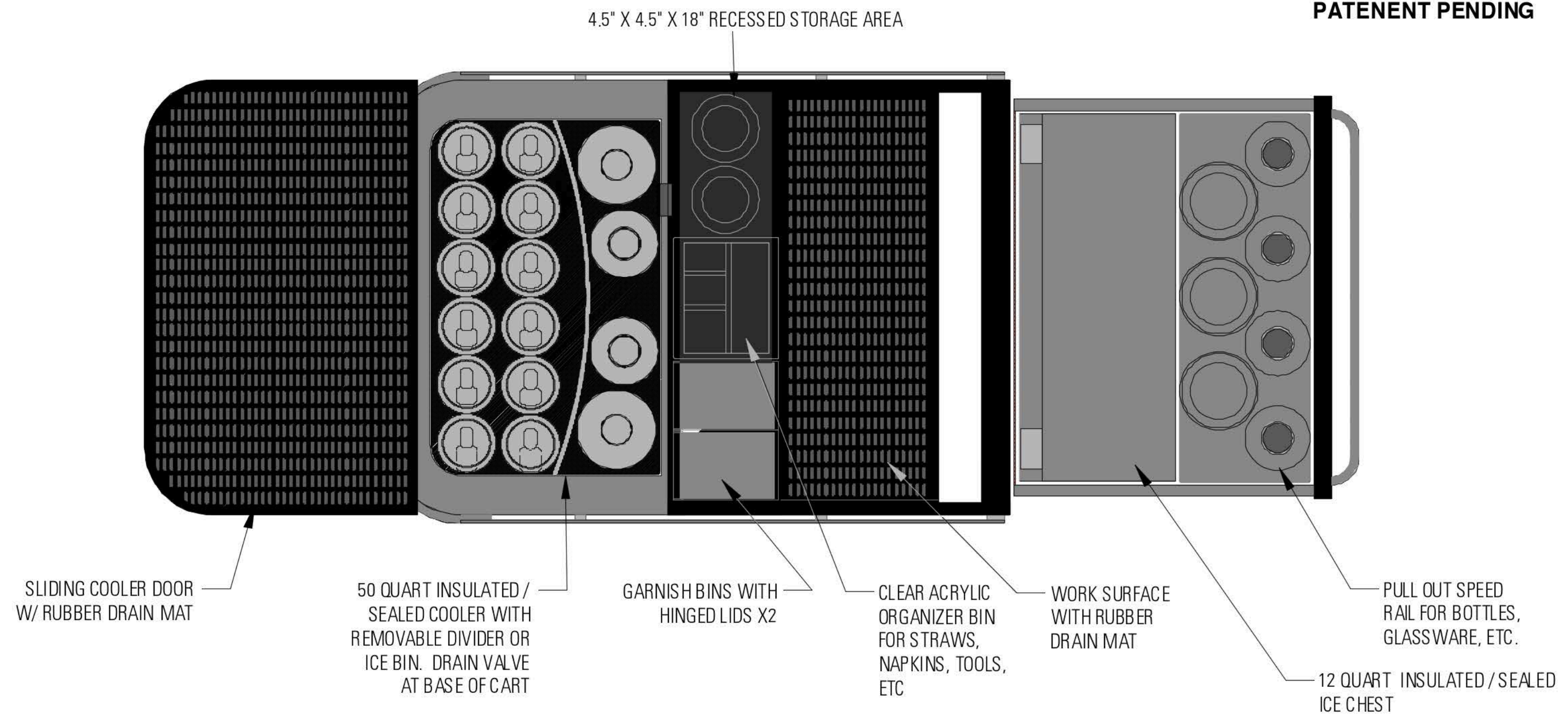

Lower Drawer / Trash Compartment

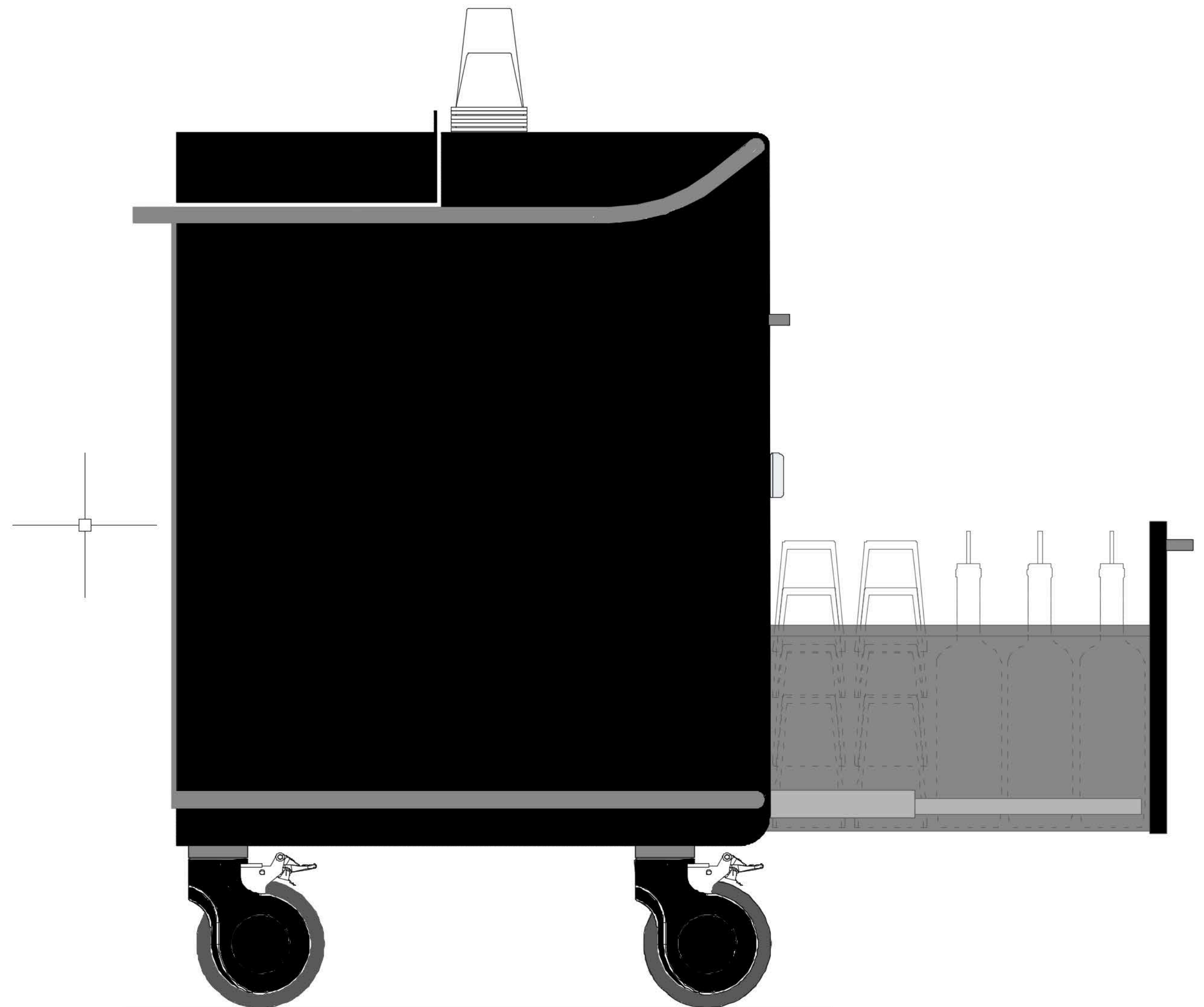
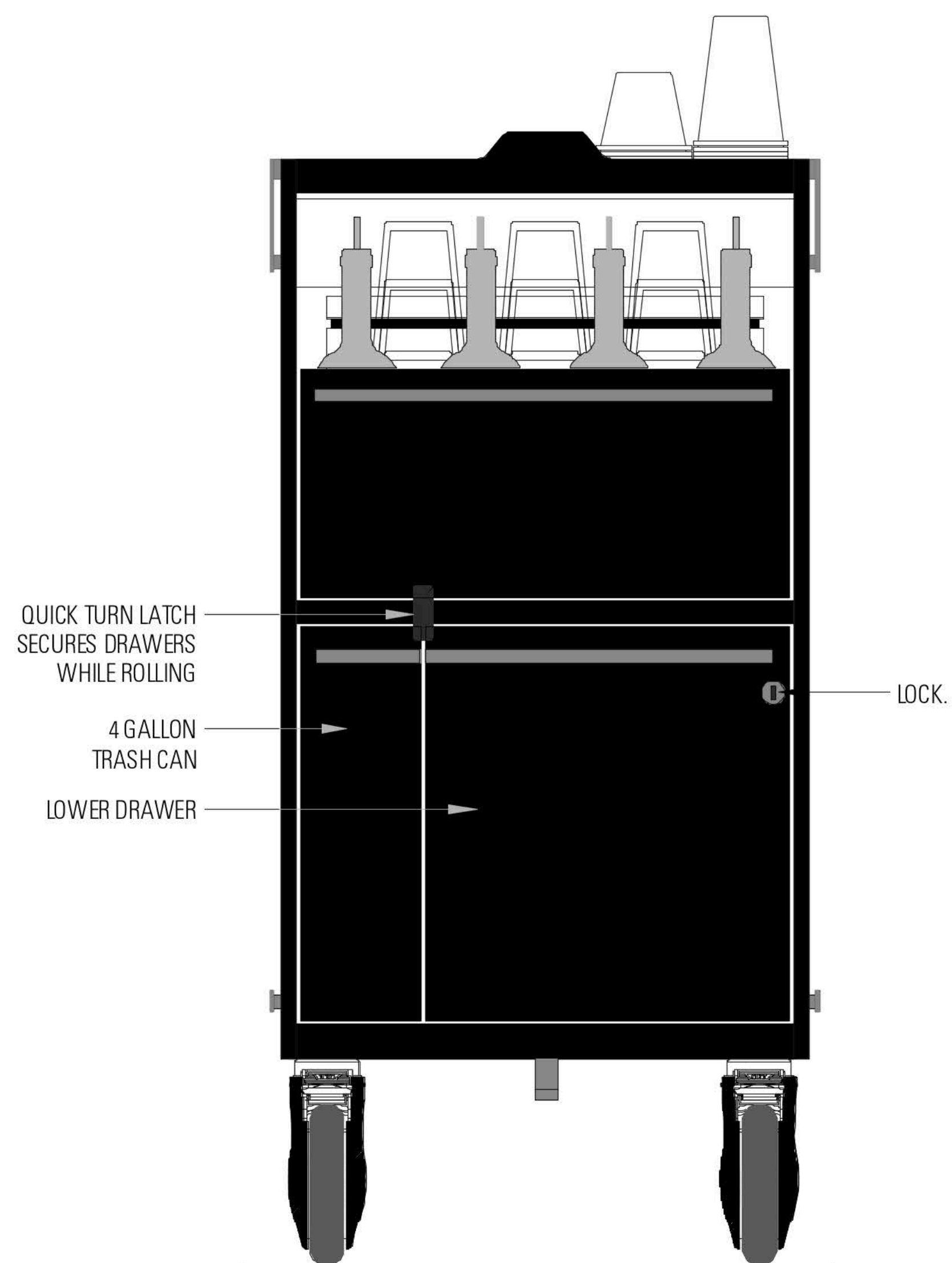
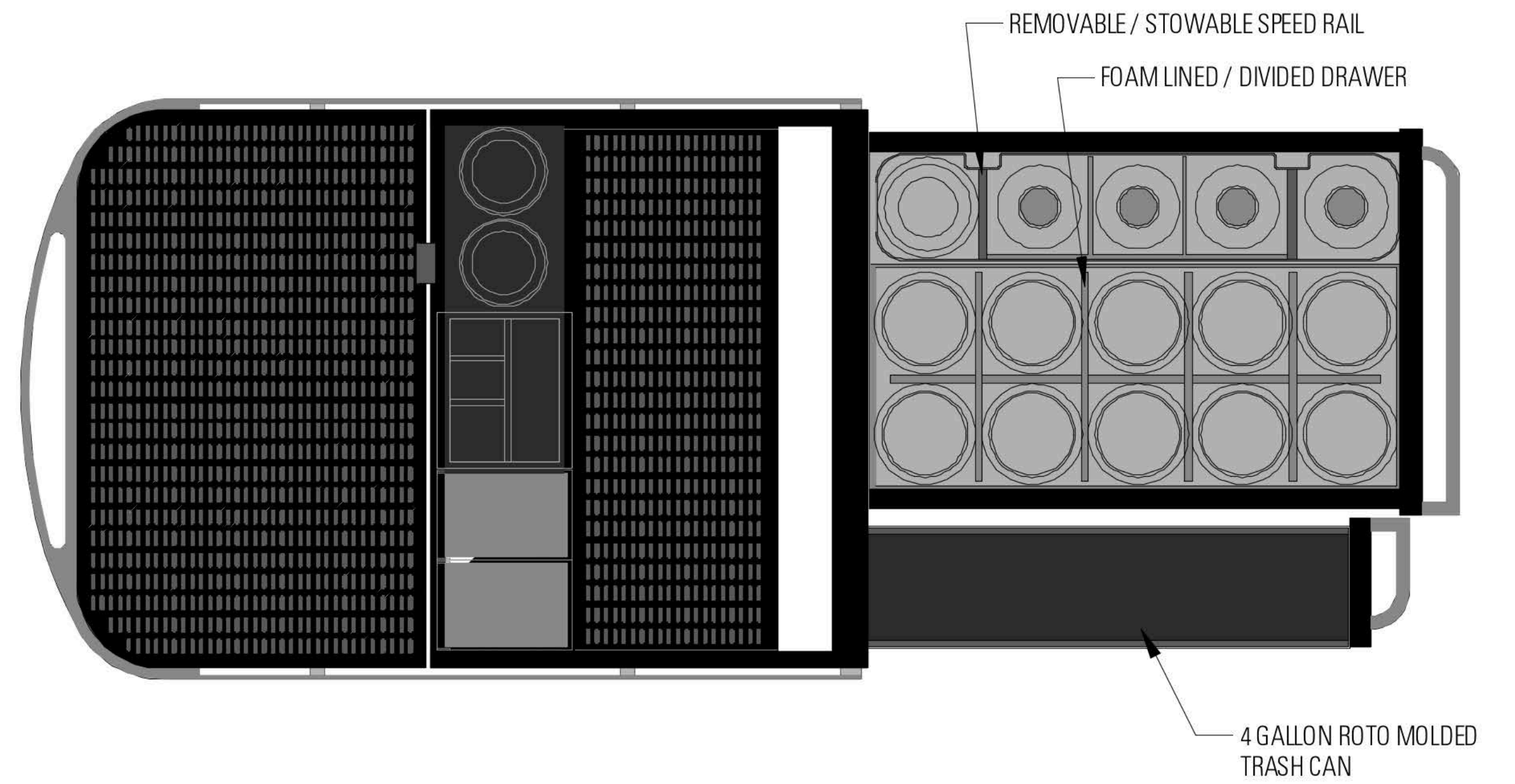

Stationary Mode

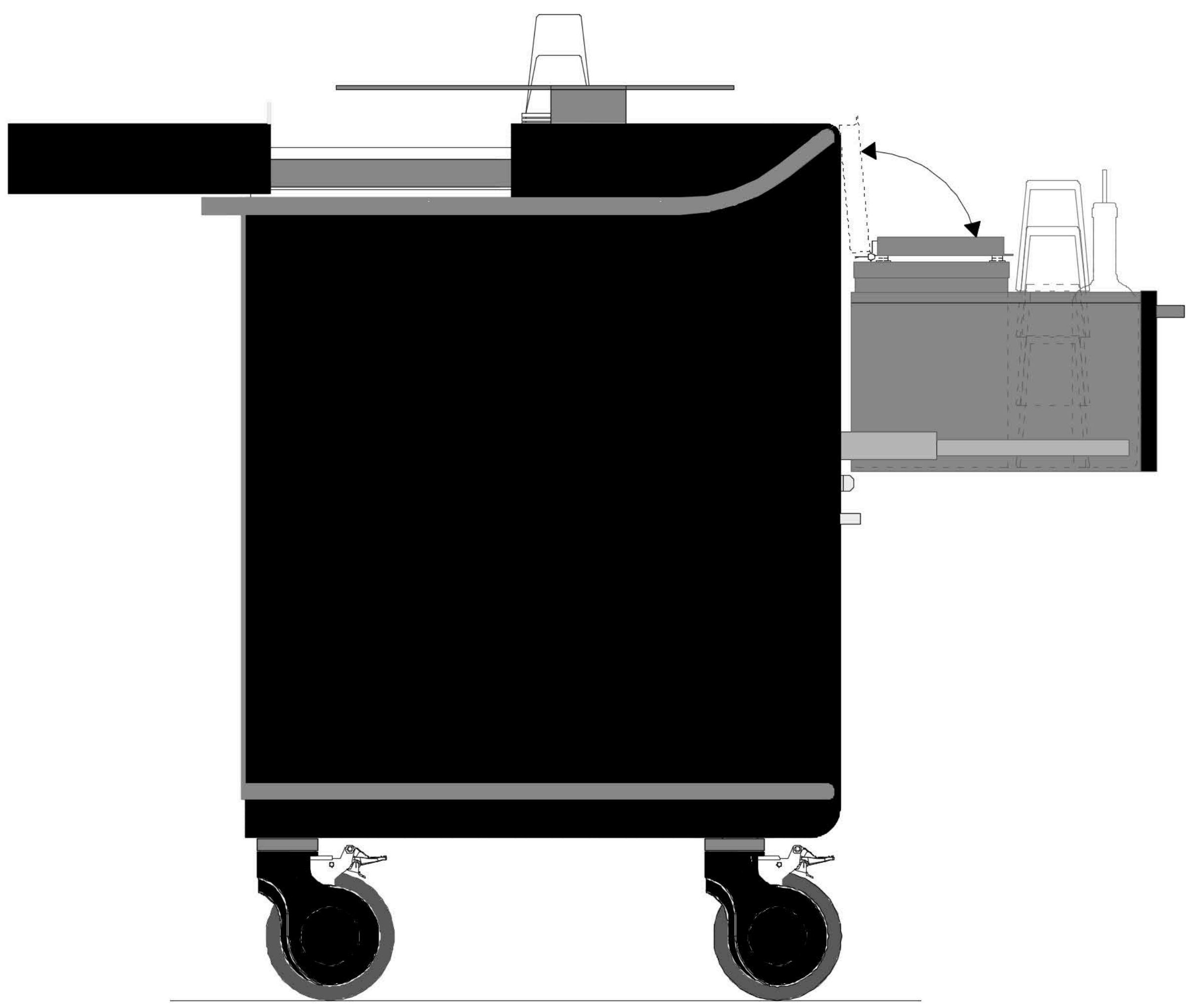
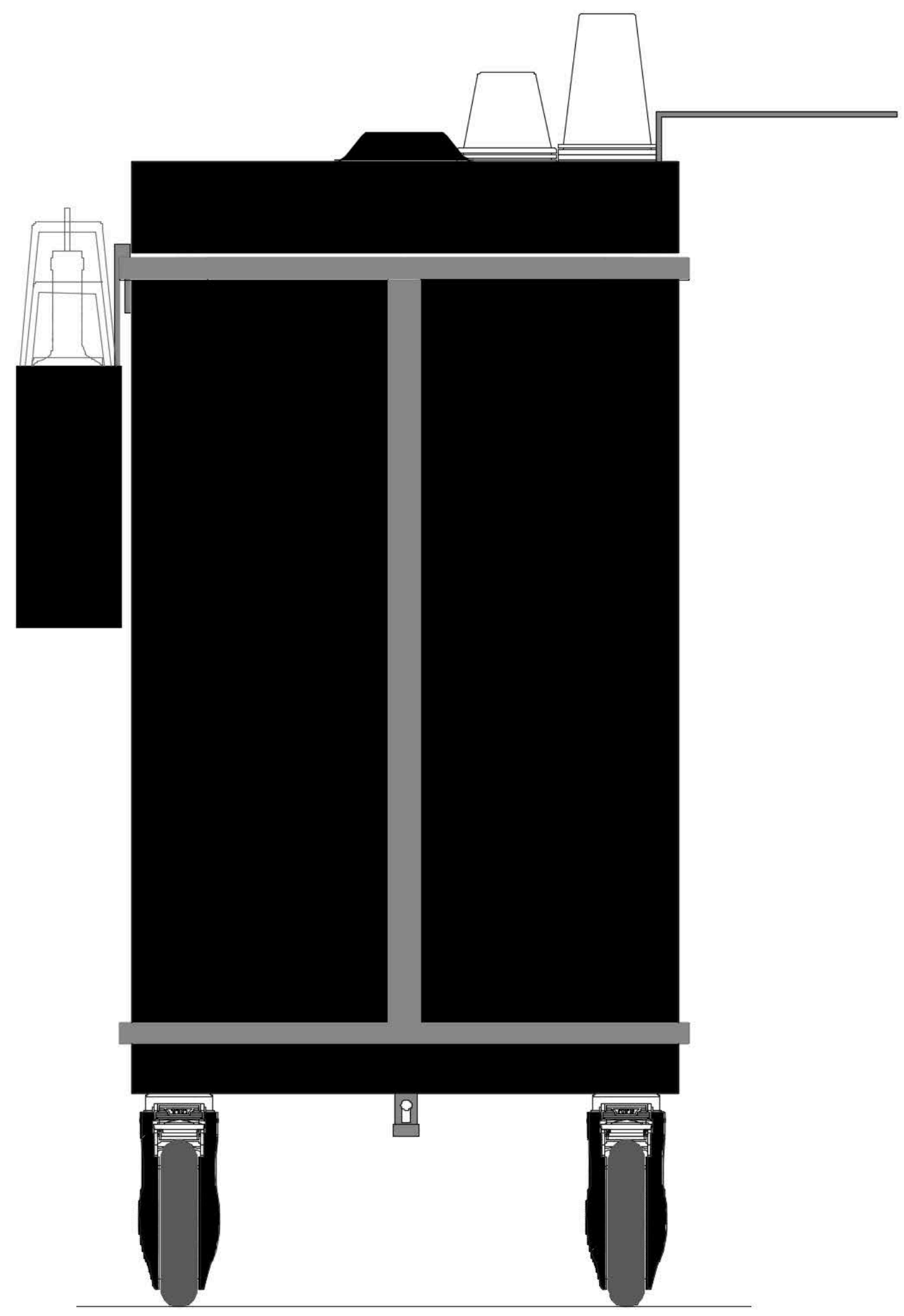
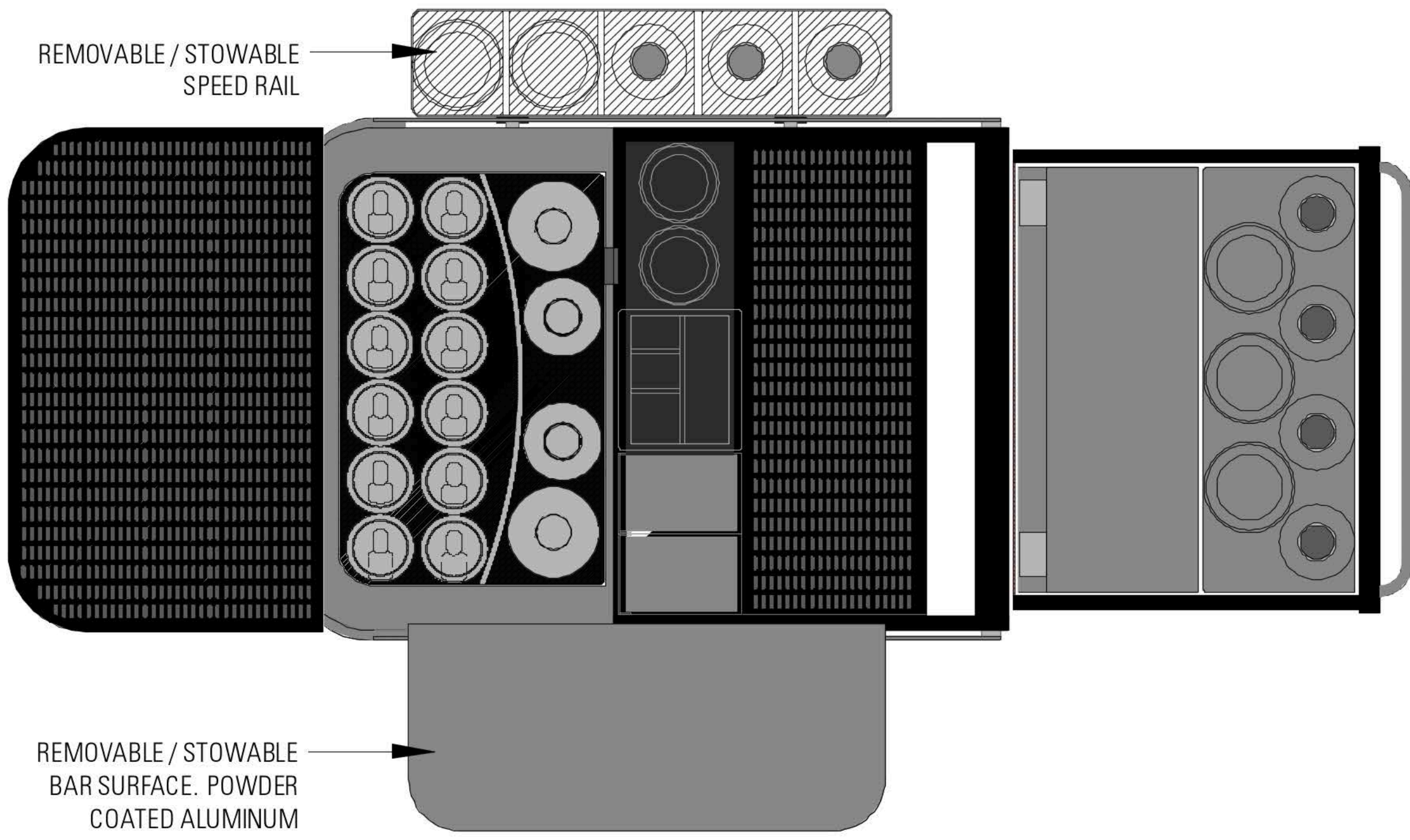

Umbrella Bracket
(for client supplied umbrella)

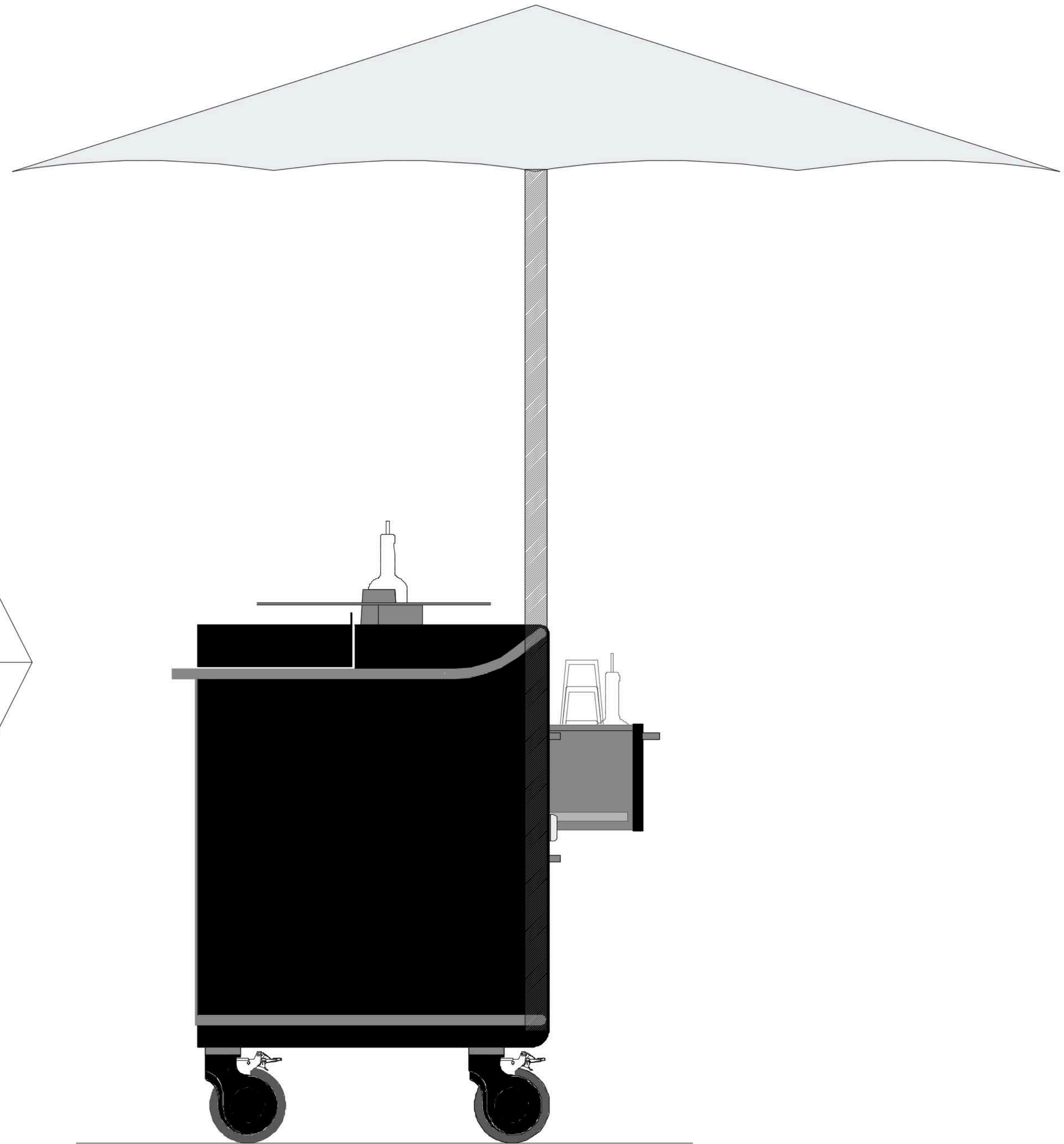
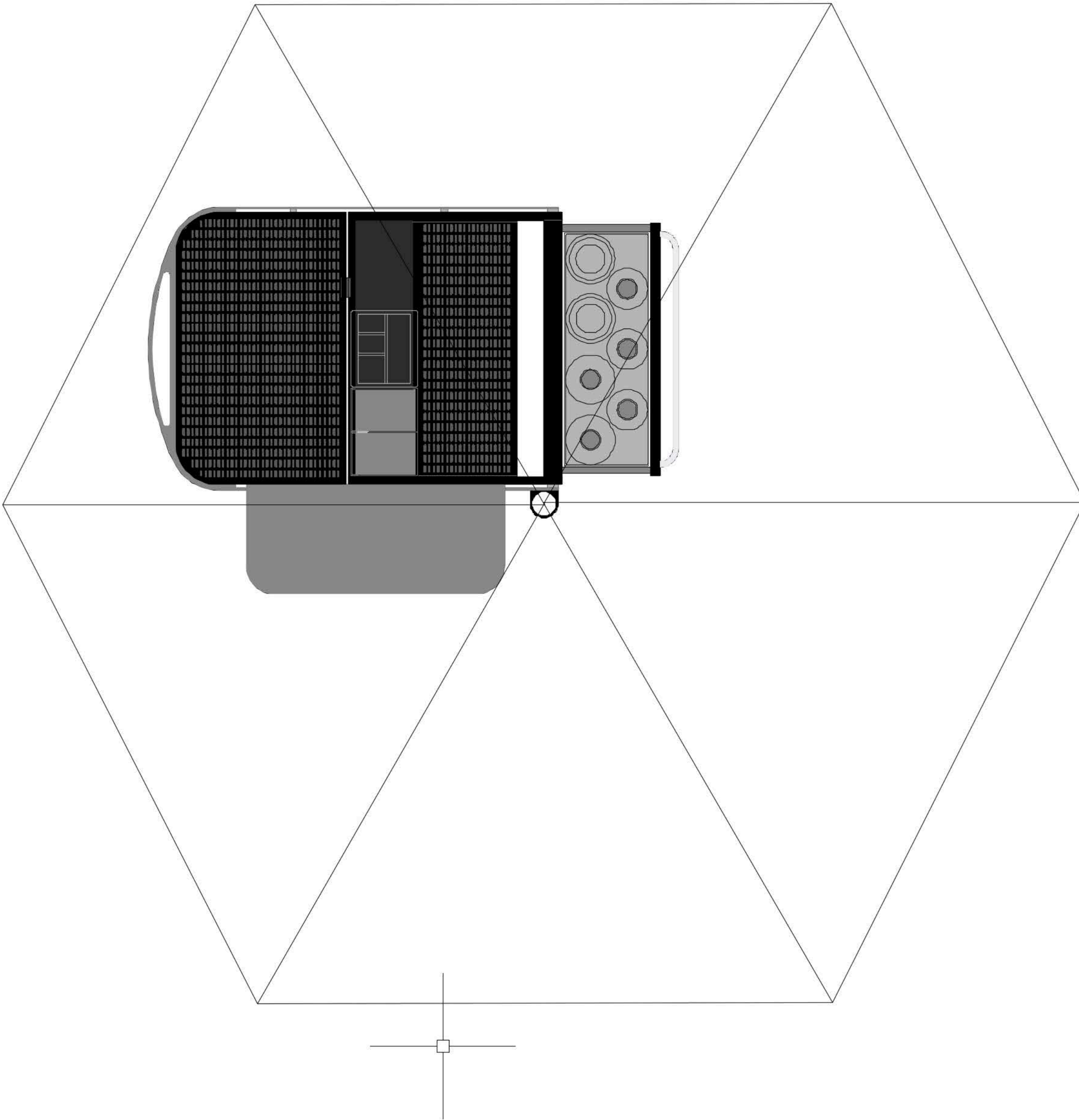

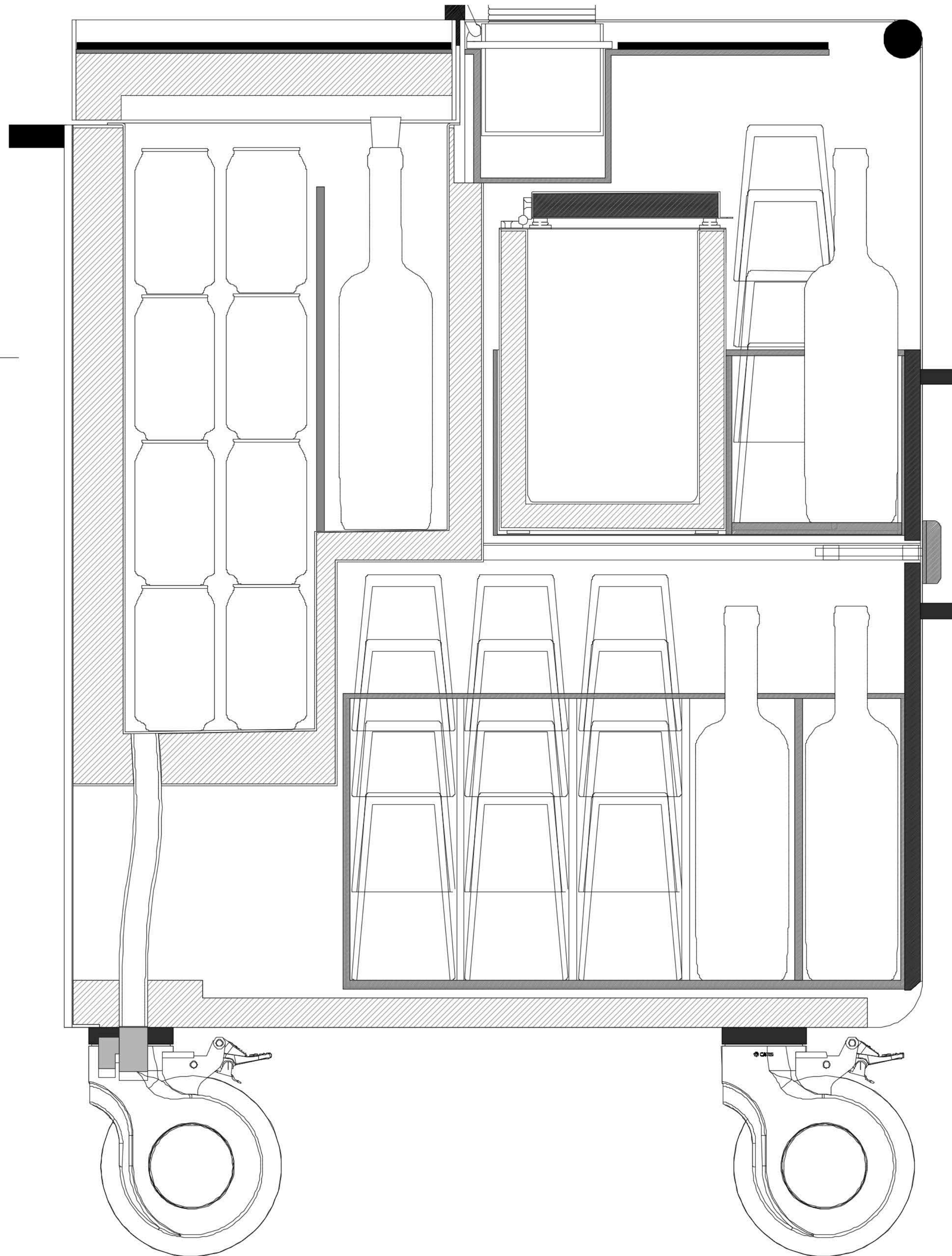

CONSTRUCTION	Aircraft aluminum body & frame, Roto molded polyethylene cooler & bins
COOLER	48 Qt. Roto molded polyethylene. Removable bottle divider. Drain. Fully insulated w/ latching sliding door.
ICE CHEST	15lb Ice Capacity (extra 15lb ice storage in cooler) Roto molded polyethylene. Fully insulated.
STORAGE	22 Adjustable Padded Compartments 3.6" x 3.6" x 14.5"
TRASH CAN	4 Gallon Roto molded polyethylene with bag retainer hoop. Trash can housing is also molded polyethylene.
DRAWER SLIDES & LOCK	Heavy duty 175lb full extension roller type slides. Turn latch safety mechanism prevents drawers from opening while rolling. Key lock on lower drawer.
CASTERS	6" Locking casters standard. Rigid type on rear and swivel type on front. Extra heavy duty indoor / outdoor. Painted Color Match wheel covers
MISC. BINS	Qty 2 Polyethylene Garnish Bins with hinged covers + napkin / tool bin.
BAR	Aluminum w/ Powder Coat finish. Stowable in lower drawer.
SPEED RAIL	Roto molded polyethylene with 5 Adjustable padded compartments 9" x 3.6" x 14.5". Stowable in lower drawer.
FINISH	Powder Coated. Painted to order in any RAL color. Custom color match auto finish also available.
GRAPHICS	Standard: 1-2 Color vinyl Logos up to 20" x 20". Custom graphics and removable graphic panel options available.
DIMENSIONS	29 1/2" Long x 20 1/8" Wide x 40" H.
TOTAL WEIGHT	98 LBS